

MODEL NO.

DESIGNED NO.

DATE

MAR.22.2012

UNIT:mm

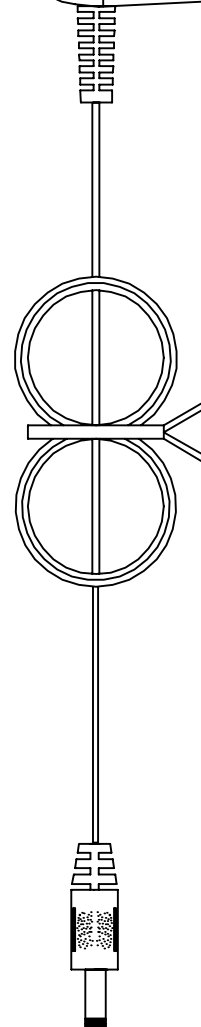
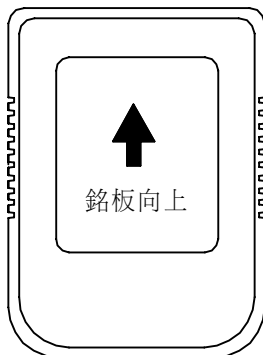
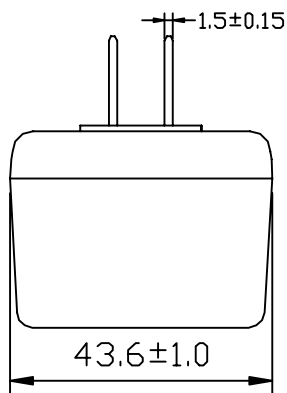
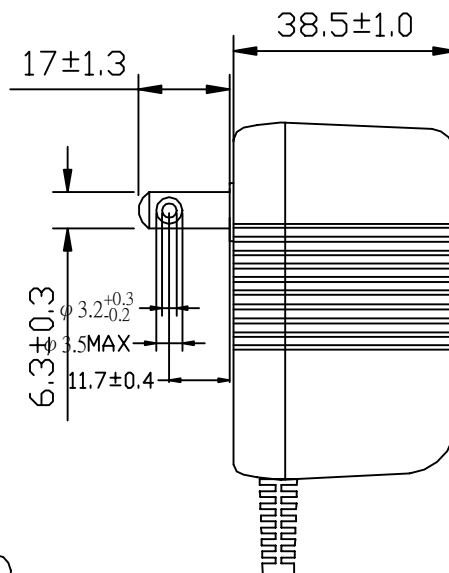
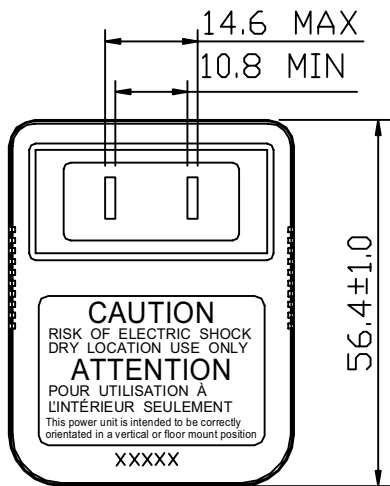

DATE CODE

X X X X X

month year C or K

kun shan hon-kwang
shen zhen hon-kwang

35弧背插銷式

EXAMINED BY:



CHECKED BY:

LIST BY:陸鳳春